



**FUSION  
FOR  
ENERGY**

---

HIGHLIGHTS  
**2022**

---

THE MAIN ACHIEVEMENTS



# 2022

## Table of contents

Foreword	2
Key figures	4
2022 at a glance	6
ITER achievements	8
Building ITER	12
Manufacturing the ITER components	18
The Broader Approach	36
Working together with stakeholders	42

# FOREWORD

Imagine if we could create a small Sun on Earth as a virtually inexhaustible and clean energy source – and although this may sound like science fiction, it is the ultimate mission of Fusion for Energy (“F4E”).

We are the main contributor to ITER – an international project to build and operate the largest research machine machine to test fusion. In parallel, we are collaborating with Japan on three smaller fusion projects to improve our technical know-how.

This has been a challenging year for F4E and the ITER project at large in several respects.

We signed new contracts with industrial partners and laboratories for a total of 500 million EUR, bringing F4E’s total financial contribution since the beginning of the project close to 6.7 billion EUR. The impact of this investment spread into technology transfers, job creation, and new commercial opportunities.

In terms of technical achievements:

- Civil works on the **Tokamak Complex buildings** progressed and we handed over the whole Tokamak Building and Diagnostics Building to the ITER Organization. There was also significant progress with the Tritium Building
- We manufactured and delivered the **eighth of ten superconducting Toroidal Field magnets**. This is the result of several complex technical operations involving more than 30 EU industrial partners
- We completed and delivered three of the five **Poloidal Field magnets** of up to 17 metres in diameter. For the two remaining coils, F4E completed vacuum pressure impregnation of one winding pack and started this for the other
- We continued working with our industrial partners to maintain the schedule and quality for the manufacturing of the five European **Vacuum Vessel** sectors that each stand 11 metres tall and weigh over 5000 tonnes, the completion of which is challenging due mostly to difficulties with the complex welding procedures under the applicable nuclear code
- We signed the contracts for the manufacturing of the 215 **Blanket First Wall Panels** that Europe is providing with two industrial partners. These panels will protect ITER’s vacuum vessel from the high heat fluxes from the fusion plasma
- After installation of the **Liquid Nitrogen Plant** and Auxiliary systems, F4E continued with commissioning. Cryogenics (liquid nitrogen) were delivered to the ITER site for the commissioning of the liquid nitrogen tank and the associated distribution system
- At the Neutral beam Test Facility in Padua, we delivered all our contributions for the **SPIDER neutral beam ion source** and transferred them to ITER. With regards to the **MITICA neutral beam source**,

the power supplies, vessel and all auxiliaries managed by F4E were transferred to ITER Organization

- There was significant progress with F4E’s twelve **diagnostics**, ten ancillary systems and integration of 6 port plugs. During 2022, among many achievements, we delivered the 2nd and 3rd batches of inner vessel diagnostic coils completing our obligations for these components
- Together with our Japanese partners, we supported the repairs of the **JT-60SA Satellite Tokamak** in Japan as part of the Broader Approach agreement aiming at a first plasma during 2023
- We continued to support the major upgrade of the **prototype accelerator LIPAc** for testing fusion materials. Among other achievements, we validated the continuous wave of the deuteron beam produced by the injector with the required characteristics.

Late in 2022, the ITER Organization detected the need for repairs in some key ITER components already delivered on the site by other members. This will have an impact on the schedule and budget of the whole project that has not yet been determined. Consequently, this led to a slow-down in some areas of the project, and impacted F4E’s 2022 budget execution. A new baseline (scope, schedule and cost) will be presented to the ITER Council for a decision during the second half of 2024. This will have impacts on some of the F4E in-kind delivery programmemes.

With regards to improving our work environment, we took several initiatives to actively listen to our staff. A “Change Agenda” exercise was launched to identify areas of improvement and propose a list of actions. In collaboration with the trade unions, we carried out a wide consultation to take stock of any concerns.

Several changes at senior management level took place in F4E and the ITER Organization. In June 2022, the F4E Governing Board appointed Pietro Barabaschi as acting Director, whom I replaced in October 2022 when he took up duties as Director General of the ITER Organization following the sad passing of his predecessor, Dr. Bernard Bigot.

Finally, F4E acted as Chair of the European Union Agencies Network (EUAN), co-ordinating the work of 49 different EU entities by overviewing strategic priorities and exchanging best practice in different areas.

As I come to the end of my career at F4E and hand over to Marc Lachaise, the next Director, I would like to conclude by thanking warmly the F4E staff and the teams of our industrial partners for their dedication, resilience, and hard work, often under very challenging circumstances.

Jean-Marc Filhol  
Acting Director



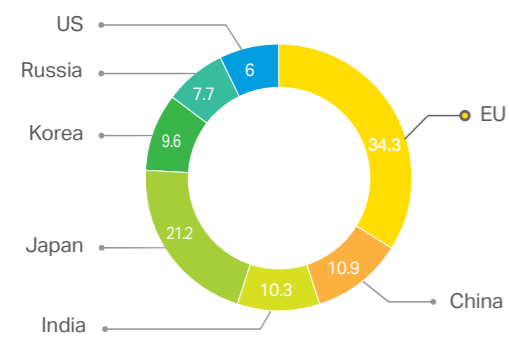

# 2022 KEY FIGURES

## Contributions to ITER

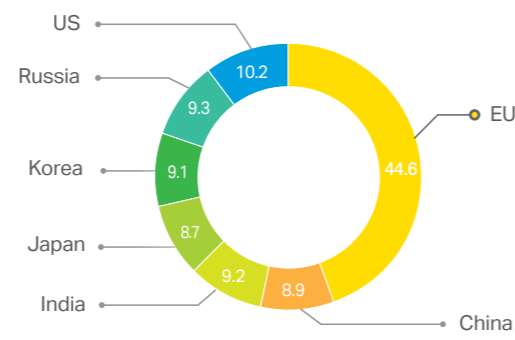

Total In Kind contributions in percentages  
ITER Parties 2007-2022



Total In Cash contributions in percentages  
ITER parties 2007-2022

## F4E budget breakdown of main activities 2007-2022

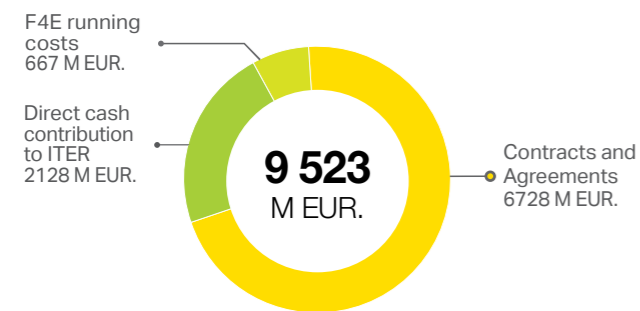

## ITER Project Progress

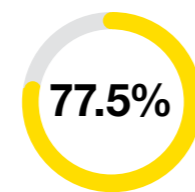

Completion towards  
ITER First Plasma

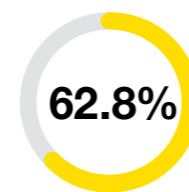

Completion beyond  
ITER First Plasma

## Geographical distribution

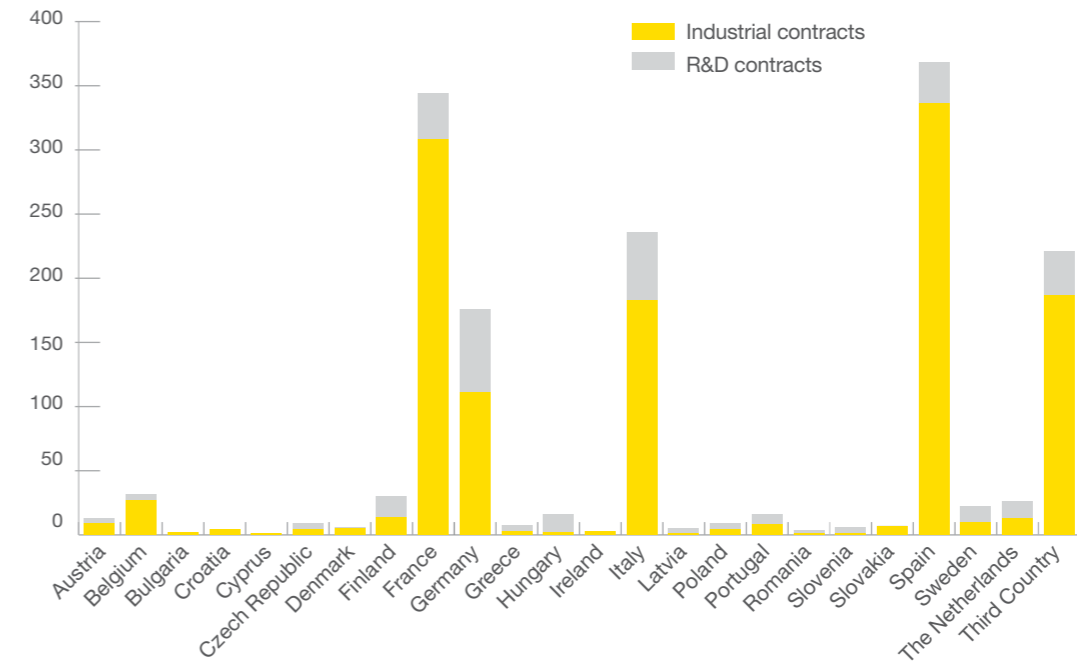

Contracts and grants awarded by F4E 2008-2022

Since 2021 the contribution of Switzerland and United Kingdom is included in "Third Country"

## Contracts with Industry and Laboratories



Total value of contracts signed  
in 2022



Total value of contracts signed  
2007-2022



Contracts signed since 2007



Companies



Subcontractors



Research Organisations

# SOME OF THE F4E ACHIEVEMENTS DURING 2022



## January

Europe delivers warm regeneration box to raise the temperature of ITER cryopumps. F4E and EUROfusion collaborate to study the behaviour of tritium in Test Blanket Modules.



## March

F4E Technology Transfer awarded to Via Electronic. Final case of ITER Toroidal Field coils delivered to Europe. MITICA Cryopump gets closer to assembly phase.



## May

Experts design software to control ITER plasma. F4E champions Green Week initiatives and promotes Diversity & Inclusion through various campaigns.

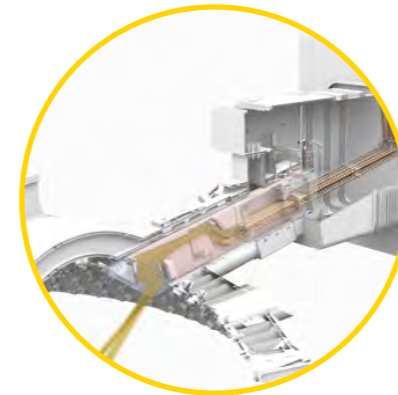

## July

F4E signs multi-million contract with IDOM and Alsymex to heat up ITER plasma. In-vessel viewing system advances towards final design. Fusion laboratories collaborate with F4E to deliver diagnostics camera.



## September

More High Voltage units pass final factory tests. Four cold valve boxes completed for ITER Cryopumps. F4E joins Big Science Business Forum (BSBF) to raise awareness on progress and business opportunities.



## November

ITER Control building and Fast Discharge facility progressing on-site. MITICA Cryopump almost completed.



## February

Delegation of MEPs visits ITER. LIPAc accelerator prepares for continuous beam operation. Experts from various organisations gather in first Neutronics workshop hosted by F4E.



## April

More progress for Europe's vacuum vessel sectors. F4E participates in the Nordic ITER Business Forum.

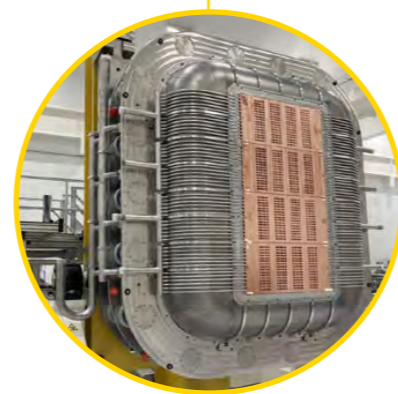

## June

MITICA beam source manufacturing advancing. Europe completes its eighth Toroidal Field coil.



## August

Contract signed with Thales for the manufacturing of six gyrotrons. Women in Fusion website goes live promoting gender equality and networking opportunities.



## October

Neutral beam remote handling crane heading for final design review. Two SOFT Innovation prizes go to technologies supported by F4E. F4E presents business opportunities at BSBF2022.



## December

Europe to start manufacturing a series of Inner-Vertical targets. Spain and Croatia sign IFMIF-DONES Agreement. JT-60SA poised for a comeback.

# SOME OF THE ITER ACHIEVEMENTS DURING 2022

All images provided by ITER Organization

## ITER Organization



The teams working on the second vacuum vessel sub-assembly. The thermal shield will be rotated toward the vacuum vessel sector and attached in place. January 2022. ©ITER Organization



First ITER central solenoid module to enter assembly process. February 2022. ©ITER Organization



Two workers stand in the central Tokamak pit, a 30-metre-tall x 30-metre-wide space where the assembly of the ITER machine is proceeding from bottom up. April 2022. ©ITER Organization



First sub-section of the ITER plasma chamber out of tooling and lowering it into the machine well. May 2022. ©ITER Organization

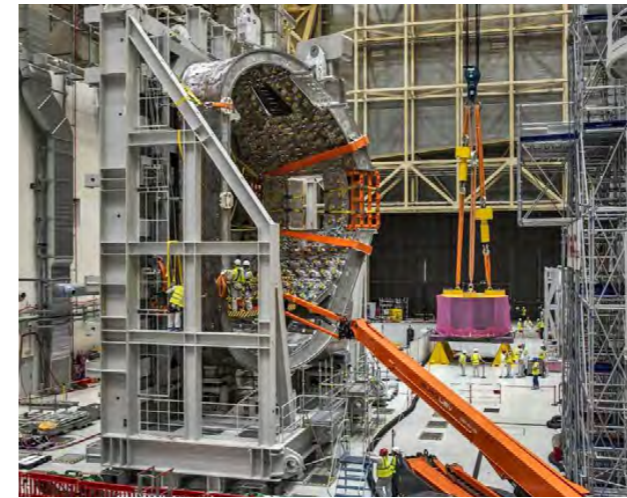

For the first time in its existence, vacuum vessel sector #8 is in a vertical position. In the background, the second central solenoid module (wrapped in pink plastic). September 2022. ©ITER Organization

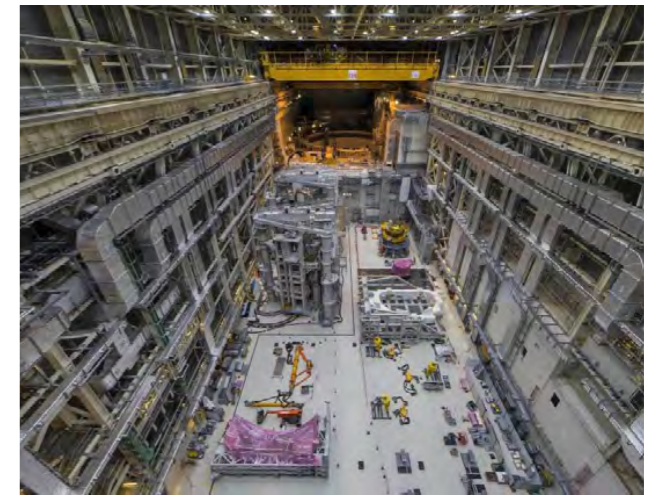

Machine components visible in this photo include an element of the vacuum vessel thermal shield (bottom left), a D-shaped toroidal field coil (lying horizontally); the start of the central solenoid stack (middle right), and a sector of the vacuum vessel (mainly hidden in vertical tooling, middle left). December 2022. ©ITER Organization

## China



Against the backdrop of vacuum vessel sector assembly, China Nuclear Power Engineering (CNPE) consortium members are preparing to move a 100-tonne central solenoid module. February 2022. ©ITER Organization

## United States

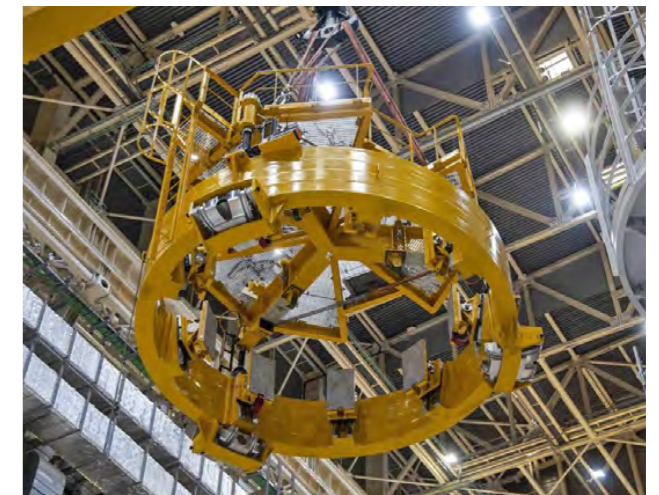

This unique tool was designed by US ITER to clutch 110-tonne central solenoid modules and hold them in its grip by exerting a strong radial force. March 2022. ©ITER Organization

## India



During the hybrid (in person and by video) celebration for the completion of the ITER cryostat, the first Commit to Deliver (C2D) award is presented to representatives of the ITER Organization, Larsen & Toubro Ltd, the Indian Domestic Agency, and MAN Energy Solutions. March 2022 ©ITER Organization



Procured by India, manufactured by INOX-CVA in India and Air Liquide in France, cryolines are high-tech, vacuum-insulated components that host several multi-process pipes transporting different cooling fluids in and out of the ITER Tokamak. October 2022. ©ITER Organization

## Japan



Plasma-facing units of the ITER divertor outer vertical target prototype have been mounted on a test assembly for high heat flux heating in Japan. January 2022. ©ITER Organization



Japan's Toroidal Field coil #15, manufactured by Toshiba Energy Systems & Solutions, loaded on a barge to reach the ITER site. September 2022 ©ITER Organization

## Korea



Vacuum vessel sector #8, from Korea, travelling at night along the ITER Itinerary. March 2022 ©ITER Organization



On 12 September, vacuum vessel sector #8, from Korea, was transferred from the upending tool (left) to the available sector sub-assembly tool on the other side of the Assembly Hall. September 2022. ©ITER Organization

## Russia



Sredne-Nevisky Shipyard (SNSZ) specialists have successfully finished factory acceptance tests on poloidal field coil #1 (PF1) in Russia. March 2022. ©ITER Organization



PF1, ITER's smallest Poloidal Field coil, on a barge in order to be transferred to a ship to begin the journey to ITER. July 2022 ©ITER Organization



# 01

---

## Building ITER

---

The ITER platform measures 42 hectares and is located in Cadarache, France. It is considered as one of the largest levelled surfaces in the world.

Europe is responsible for the construction of 39 buildings, the infrastructure and power supplies on-site required to operate the world's biggest fusion device.

More than 2 000 people working for European companies have been involved in ITER's civil engineering works. Architects, engineers, technicians, planners, inspectors are some of the professionals contributing to the project. Inside these facilities, the components arriving from all over the world will be stored, assembled and installed.

Our teams on the ground are preparing the "home" of one of the most impressive technology projects.



# THE ITER SITE

There was steady progress on the ITER site with more civil engineering works advancing in parallel. F4E handed over to ITER Organization the Tokamak building, the home of the biggest fusion device, and Diagnostics building, where the equipment monitoring the performance of the device, will be installed. More operations in the Assembly Building, and the insertion of components in the tokamak pit were some of the main developments unfolding on-site.

With nearly 80% of the buildings and infrastructure completed for first plasma operations, the F4E Buildings, Infrastructure and Power Supplies (BIPS) team made further progress with buildings that will host people and equipment essential for operating ITER.

The works for the non-nuclear part of the Control Building were completed in order to receive the first equipment starting with the electrical components. This will be one of the ITER flagship buildings where operators will work to monitor the performance of the device. An underground tunnel will connect the building with the ITER Organization headquarters to facilitate access. The other part of the building, needed for the second phase of the ITER experiment, should be ready by 2030.

The ITER Fast Discharge Building also advanced. The design activities started in 2019, stemming from the collaboration between Demathieu Bard Construction and F4E. The civil engineering works were completed in autumn 2022. Inside this facility, fast discharge resistors will be housed to extract and discharge an excess of energy received by the superconducting magnets, which will dissipate from the chimneys to be erected at a later stage. It is expected that the remaining works will be completed in autumn 2023 with electrical supplies and ventilation commissioned.

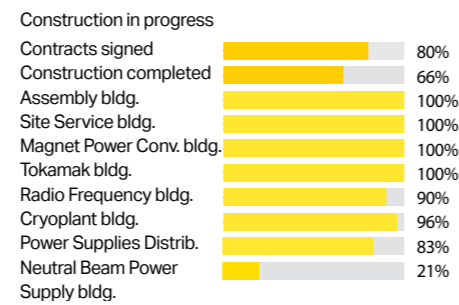

Caption: Aerial view of the ITER site, Cadarache, France © ITER Organization

## ITER TOKAMAK BUILDING



Against the concrete structure of the Tokamak Complex, the frame of a new building is emerging: the tall High Voltage Building that will house the high voltage equipment for neutral beam injection. November 2022. ©ITER Organization

## NEUTRAL BEAM POWER SUPPLY



From the roof of the Diagnostics Building, we are looking directly down at the site of the future ITER Neutral Beam Power Supply buildings, currently under construction by F4E contractors. April 2022. © ITER Organization

**HIGH VOLTAGE SUPPLY BUILDING**



At 25 metres tall, the High Voltage Supply Building, will partially obscure the Tokamak Complex, rising several metres higher than the four transmission line openings that are visible in the concrete facade. July 2022. © ITER Organization

**CONTROL BUILDING**



View of the ITER Control Building, connected under the ground with ITER Organization Headquarters, ITER Construction site, Cadarache, France, September 2022 © ITER Organization

**TRITIUM BUILDING**



Last level of concrete poured at Level 5, bringing the structure to full length. December 2022 © ITER Organization

**FAST DISCHARGE BUILDING**



Aerial view of ITER construction site, where steel frame works of the Fast Discharge facility can be seen on the right of the Tokamak Complex, Cadarache, France, April 2022 © ITER Organization



# 02

---

## Manufacturing the ITER components

---

ITER is the biggest international scientific partnership to test the potential of fusion energy. It's an impressive technology puzzle that will generate new knowledge and stimulate industrial expertise to manufacture its components.

Europe's contribution to ITER, financed by the EU budget, amounts to roughly 50% making it the biggest of all Parties. It is one-of-a-kind opportunity for industry, SMEs and fusion laboratories to get involved and be part of an emerging energy market.

During 2022, Europe delivered eight of its ten Toroidal Field coils. Meanwhile on-site, where the Poloidal Field coils are produced, the winding activities were concluded, paving the way for the final two coils to be completed. The manufacturing of the vacuum vessel sectors made headway in different facilities, while the signature of the contract for the fabrication of 215 Blanket First Wall panels started a new chapter for F4E's In-Vessel contribution. The commissioning of the Liquid Nitrogen Plant advanced as part of the ITER cryogenics system. More power supplies were delivered to the ITER site, while significant progress was made with the components of the MITICA beam source, plus the signature of an important contract for power supplies. Significant progress was also made in the field of Diagnostics and ancillary systems with more equipment completed.

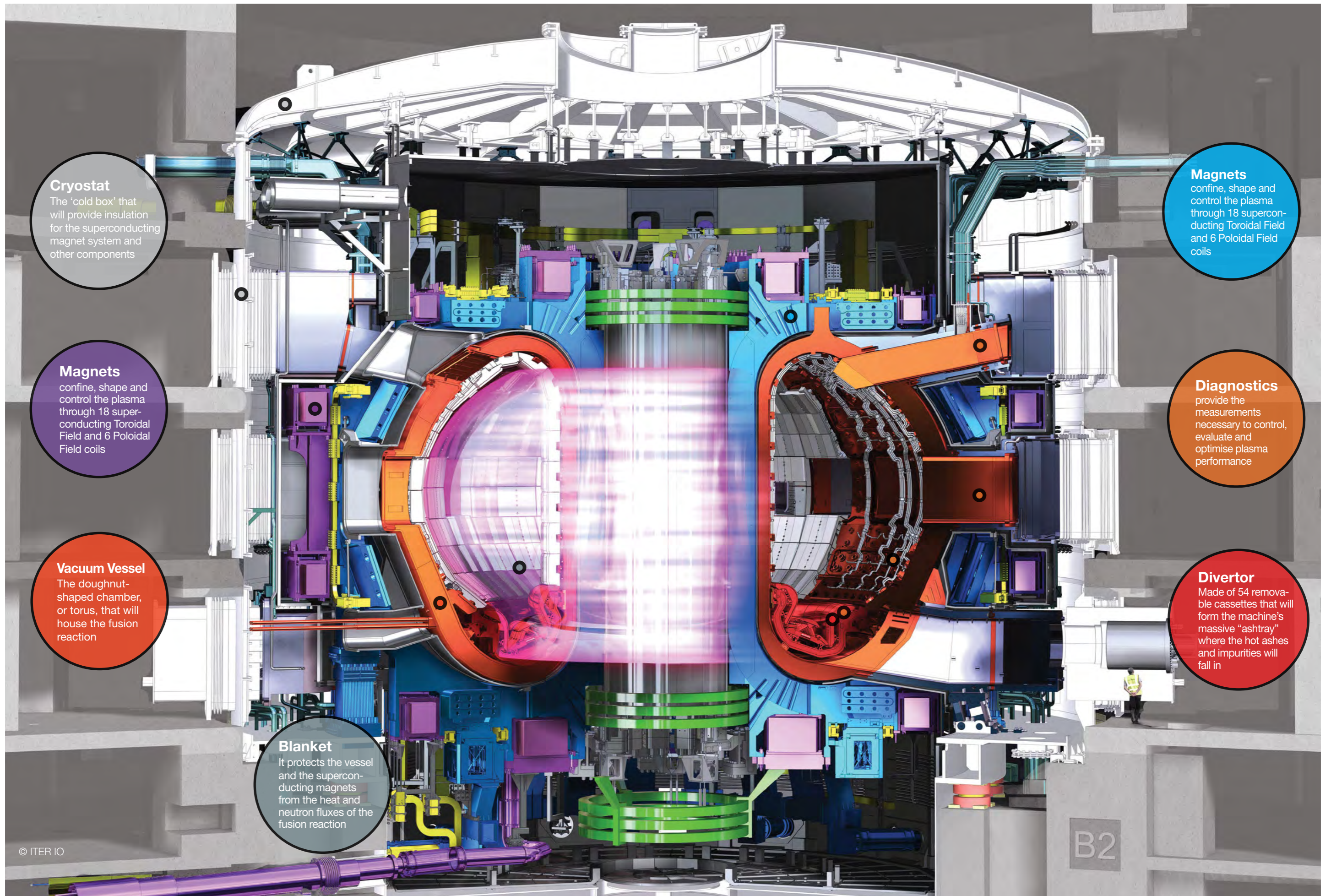

**Cryostat**  
The 'cold box' that will provide insulation for the superconducting magnet system and other components

**Magnets**  
confine, shape and control the plasma through 18 superconducting Toroidal Field and 6 Poloidal Field coils

**Vacuum Vessel**  
The doughnut-shaped chamber, or torus, that will house the fusion reaction

**Blanket**  
It protects the vessel and the superconducting magnets from the heat and neutron fluxes of the fusion reaction

**Magnets**  
confine, shape and control the plasma through 18 superconducting Toroidal Field and 6 Poloidal Field coils

**Diagnostics**  
provide the measurements necessary to control, evaluate and optimise plasma performance

**Divertor**  
Made of 54 removable cassettes that will form the machine's massive "ashtray" where the hot ashes and impurities will fall in

# MAGNETS

ITER will operate with the largest and most integrated superconducting magnet system ever built. It will help scientists to confine, shape and control the burning plasma.

The central solenoid will act as the magnets' backbone and the correction coils will reduce any errors resulting from the position and geometry of other coils.

The Toroidal Field (TF) coils will create a massive magnetic cage to confine the plasma, expected to reach 150 million °C, by keeping it away from the walls of the vacuum vessel. Europe has manufactured 10 out of the 18 TF coils involving more than 700 people from 40 companies. Japan will manufacture the remaining eight plus one spare.

To cope with the fatigue exercised on the TF coils, and with any deformation resulting from the powerful magnetic fields, three Pre-Compression Rings (PCRs) will be placed on top of them and three below them. An extra set of three will be provided if there is a need to replace the lower set. Europe is responsible for the production all PCRs.

Finally, six Poloidal Field (PF) coils will embrace the TF coils from top to bottom in order to maintain the plasma's shape and stability. Europe is responsible for five of them, of which one manufactured in China, with the agreement to perform cold and final tests in the F4E PF coils factory on-site. The remaining coil is produced in Russia.

TF Coils manufacturing	99%*
PF Coils manufacturing	90%
Pre-Compression Rings	100%

\*All 70 Radial Plates and 10 Winding Packs are completed. The remaining 1% represents the work calculated over the entire production.

## TOROIDAL FIELD COILS

### Europe delivered two more Toroidal Field coils

Eight of the ten European TF coils have been completed and transported to the ITER site. F4E in collaboration with its contractors have successfully produced two more magnets keeping the final two for the year after. Also, early in the year, Japan sent to Europe the last TF coil case to insert our tenth magnet. A small online ceremony was organised to celebrate the spirit of collaboration between the two parties looking back on some of the

key moments. SIMIC organised an event bringing together 100 people to witness the remaining manufacturing steps and celebrate their contribution. This was not only an event that marked a significant technical milestone. It also marked an important human milestone resulting from an effort which started nearly 14 years ago, counting 40 companies and more than 700 people from all over Europe.



Attendees of the SIMIC Open Day standing close to Europe's eighth Toroidal Field coil ready to be shipped to France, 27 May, Porto Marghera, Italy. May 2022. ©SIMIC



Completion of the fifth (middle) Toroidal Field coil case for Europe, manufactured by Toshiba in collaboration with QST, Japan. February 2022 ©QST

## POLOIDAL FIELD COILS

With three Poloidal Field (PF) coils already delivered to ITER Organization, and two in the making, Europe's teams started a new chapter. Following the reconfiguration of the tooling to wind lengths of conductor for magnets of 24 m in diameter, all winding works were successfully completed for PF2, 3, 4, and 5. Consequently, the stations of winding, joints and terminations were completely dismantled because they would no longer be needed. The final Double Pancake of Europe's last coil, PF3, was completed. There was also good progress with the final assembly of PF4.



End of all winding activities for Europe's Poloidal Field coils. Members of staff from F4E, ITER Organization, ASG Superconductors, CNIM, DALKIA, Apave celebrating the technical achievement, Poloidal Field coils factory, Cadarache, France, June 2022. ©F4E

Our PF coils team received the ITER Organization 2022 First-of-a-kind component award for its work. The exceptional challenges they faced, and achievements, were praised during a ceremony towards the end of the year. In terms of manufacturing, the final steps for PF3, PF4 started. When completed, they will be the world's largest superconducting magnets.



In July, contractors to the European Domestic Agency carry out the vacuum pressure impregnation (VPI) of poloidal field coil #4. July 2022. ©ITER Organization



Stacking of the final Double Pancake of ITER Poloidal Field coil 3, performed in Europe's PF coils factory, Cadarache, France, December 2022. ©F4E



(L-R) Yuri Ilin, ITER Organization, Tatiana Bomfim, ATG; Fabrice Simon, ITER Organization, Monica Martinez, F4E, Pierre Gavouyere-Lasserre, F4E, Guillaume Aubry, ATG, at the ITER Organization End-of-Year event, receiving the 2022 first-of-a-kind component award. November 2022. ©ITER Organization

## VACUUM VESSEL

The vacuum vessel is a special double-walled container that will house the fusion reactions of the ITER plasma. Within this doughnut-shaped vessel, plasma particles will collide and release energy without touching any of its walls thanks to magnetic confinement.

Europe is providing five of the nine vacuum vessel sectors of thick special grade stainless steel. Manufacturing these first-of-a-kind components is very challenging due to the strict technical requirements compliant with nuclear standards, the application of new techniques, and last but not least, their sheer size as each sector is 12 m high, 6.5 m wide and 6.3 m deep. The sectors weigh approximately 500 tonnes each. At least ten European companies are involved in their fabrication.

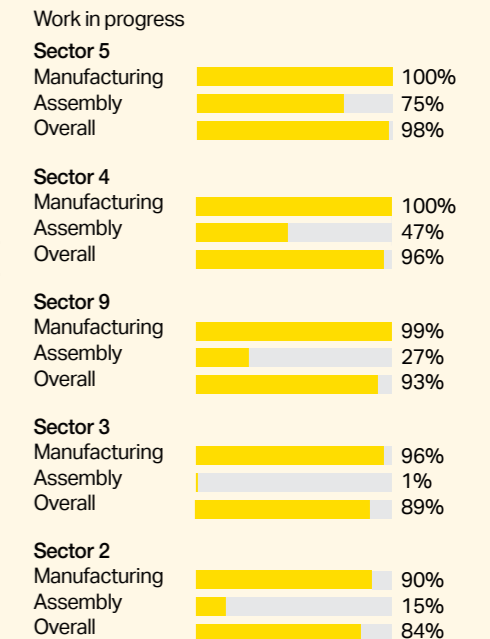

### Works progressing for Europe's vacuum vessel sectors

A total of 100 people from approximately 15 companies have been involved in the manufacturing of ITER's Vacuum Vessel sector 5. Its four segments, weighing in total 500 tonnes, were placed on the assembly frame, in the factory of Mangiarotti, Italy. The works paved the way for the in-welding shielding blocks, the joint ribs, and the outer shells to be installed. These pieces fixed internally and externally, make the component even more robust. With regards to Europe's sector 4, the second in line to be delivered, all its components arrived in the brand-new workshop of Walter Tosto in Ortona, Italy. In parallel, there was further progress with the welding operations of segments for sectors 2, 3 and 9 in the workshop of ENSA, Spain.



Final assembly of Europe's sector 4 of the ITER Vacuum Vessel, Walter Tosto, Italy, May 2022. ©F4E

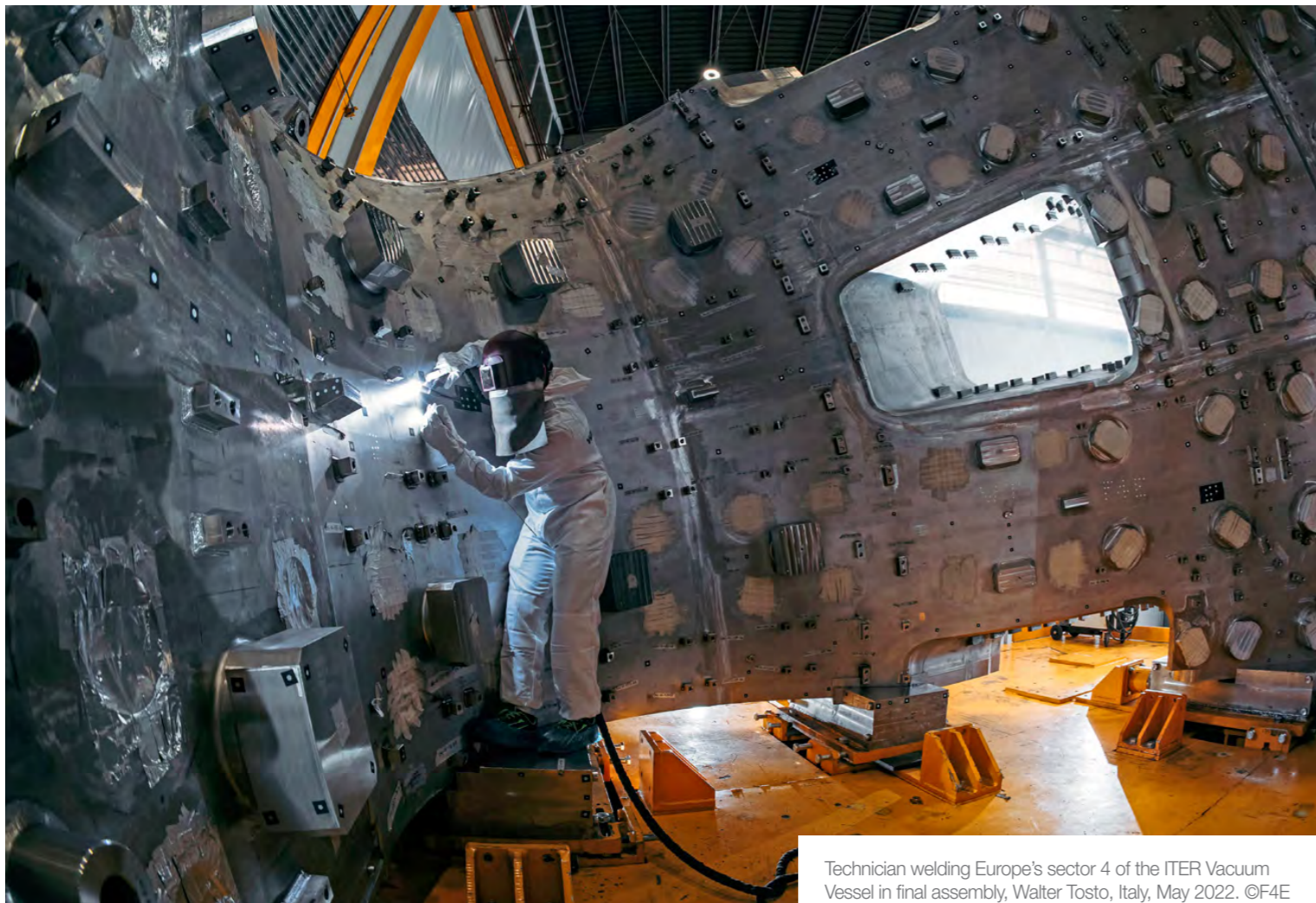

Technician welding Europe's sector 4 of the ITER Vacuum Vessel in final assembly, Walter Tosto, Italy, May 2022. ©F4E



Mangiarotti technician performing inspection at Europe's Sector 5 of ITER Vacuum Vessel, Mangiarotti, Italy, May 2022. ©F4E



Assembly under completion of Europe's Sector 5 of ITER Vacuum Vessel, Mangiarotti, Italy, May 2022 ©F4E.



Walter Tosto technicians performing checks on Europe's sector 2 poloidal segment 3 of the ITER Vacuum Vessel, Walter Tosto, Italy, May 2022. ©F4E

# REMOTE HANDLING

Remote handling helps us to carry out tasks without being physically present. It is widely used in space exploration missions, underwater repairs or challenging maintenance works. The limited space inside ITER together with the weight and exposure of some of the components to radiation will require the use of remote handling systems during maintenance. Europe is responsible for four of the six-major remote handling systems of ITER. For each of them it carries out design activities, R&D and manufacturing in order to deliver the appropriate tooling.

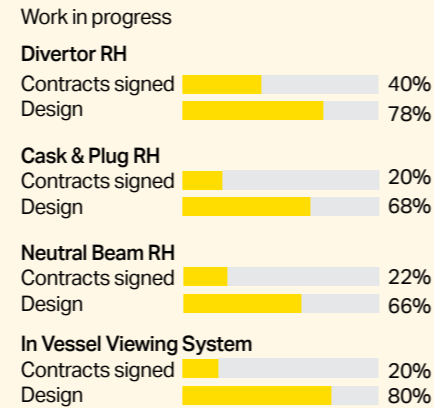

## Contract signed for final design of In-Vessel Viewing System

In this year's report we focus on two areas which reported significant progress. The In-Vessel Viewing System (IVVS) will scan the interior of the vacuum vessel to obtain information about the state of the plasma-facing components, any damage or erosion. The system will have six cartridges located in different vacuum vessel port extensions. A probe will be deployed from each cartridge, like a sophisticated periscope, to see where our eyes cannot. F4E signed a contract with Bertin Technologies to develop the final design of the IVVS Measurement System. This design phase will build on lessons learnt from the full-scale prototyping and testing activities which started in late 2020.

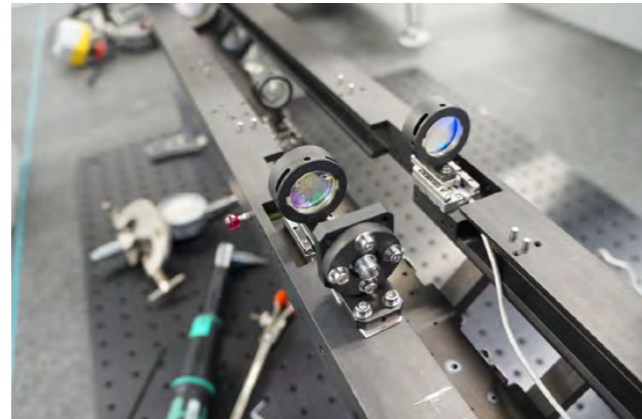

Prototype of the IVVS Measurement System probe, during assembly. ©F4E

## Neutral Beam Monorail Crane prototype developed

There was also progress with the Neutral Beam Remote Handling crane. Up to three neutral beam injectors will provide 16.5 MW of heating power each to help reach the 150 million °C needed for ITER's fusion reaction. These injectors will be located in the neutral beam cell, an area in the Tokamak building with radiation levels too high to allow access to humans. Any maintenance will need to be carried out using remote handling systems. The Monorail Crane is the backbone of the neutral beam's cell remote maintenance system, as most operations will depend on it. F4E experts with the support of Jacobs and REEL, developed a prototype of the crane to test most of its features. The manufacturing of the first components started in 2020 and the assembly of the crane one year later. Testing was carried out with very satisfactory results paving the way for the final design of the system.



The neutral beam remote handling crane prototype in REEL's premises, France. May 2022. ©F4E

# DIAGNOSTICS

The Diagnostics systems will help scientists to study and control the plasma behaviour, measure its properties, and improve our understanding in the respective field of physics. This system will act as "the eyes and ears" of engineers giving them insight thanks to a wide range of cutting-edge technologies.

ITER will offer an unparalleled view of the entire plasma, whose pulse duration will be 100 times longer than any fusion device currently in operation. The diagnostic systems will also help to them to ensure the safe operation of the machine, given the extreme environment in the vessel and the large amounts of energy inside the plasma. Europe is responsible for roughly 25% of all Diagnostics in ITER, involving more than 60 companies and research laboratories.

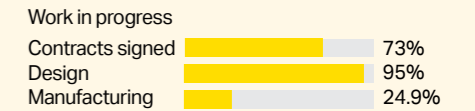

## Equipment in progress to detect operations and transmit information

One of the components that the F4E team worked on was the Radial Neutron Camera (RNC), which will detect neutrons and assess the performance of the reaction. The RNC will be located in ITER Equatorial Port 1, subjected to extreme temperatures and high neutron fluxes. F4E made progress with the final design resulting from a collaboration with several European fusion laboratories such as ENEA (Italy), IST (Portugal), IFJ PAN and IPPLM (both from

Poland). Furthermore, F4E signed a contract with Gutmar to manufacture an electrical system that will transmit information from the divertor cassettes outside the vacuum vessel. The In-Divertor Electrical Services (IDES), will connect sensors mounted on the divertor cassettes to electrical cabling in the vacuum vessel, which will transmit the signals outside the ITER device for experts to analyse them.

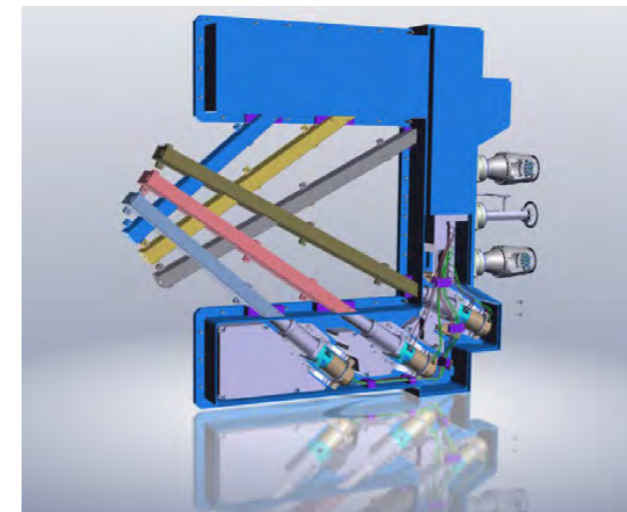

View of ITER Radial Neutron Camera port-plug components. F4E completed the design of the port-plug part of the Radial Neutron Camera (RNC) and moved forward with the manufacturing. ©RNC Consortium

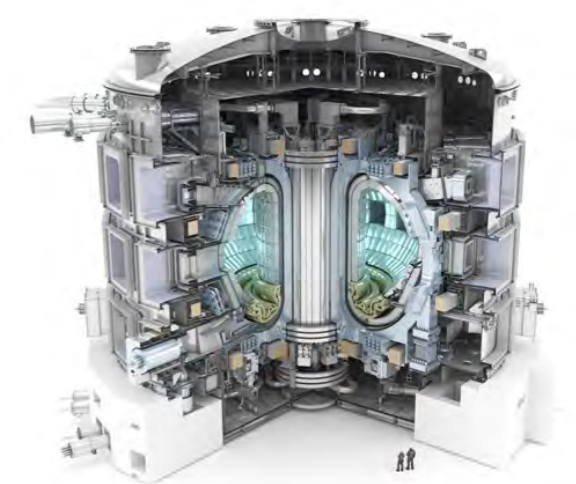

Out of the 54 divertor cassettes, placed at the bottom of the vacuum vessel, 16 of them will host sensors as part of the In-Divertor Electrical services contract signed with Gutmar. ©F4E



# TEST BLANKET MODULES

Experts working in the area of Test Blanket Modules Systems (TBMS) are among those who will use ITER to understand how tritium can be continuously bred in order to keep the fusion reaction going. Without a doubt, the lessons drawn will have significant implications towards the design of future fusion reactors like DEMO. In essence, they will be generating a new nuclear system and licensing using advanced materials and top fabrication techniques.

## Tritium transport modelling developed

Some of the areas of work worth highlighting include the development of the tritium transport modelling. Thanks to a long and fruitful collaboration from 2011 to 2018, between F4E, CIEMAT (Spain) and Empresarios Agrupados (Spain), a first version of the “EcosimPro” simulation code was developed. It implements the physics of tritium transport in the different TBS subsystems. Since then, following an agreement between F4E and EUROfusion, the activity continued with the same contractors but under the co-ordination and budget of EUROfusion.

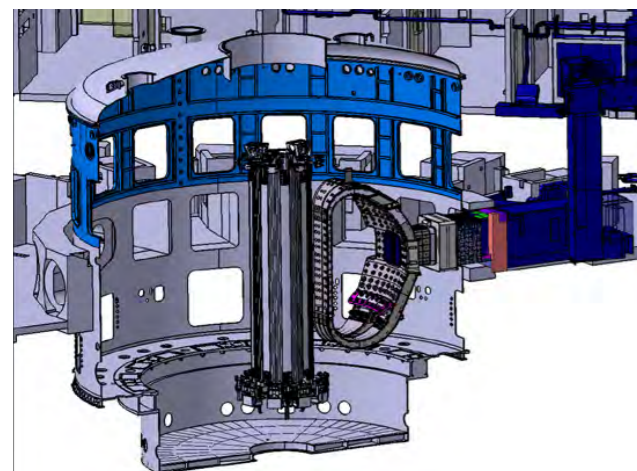

Layout of a TBM set that will be installed in the equatorial port 16 of ITER Vacuum Vessel. January 2022. ©F4E

## Progress with Europe’s Test Blanket Modules

Moreover, the teams working on the two European Test Blanket Modules (TBM) met to discuss the design and manufacturing. Designers had the possibility to explain their latest advancements, and manufacturers were there to point out possible constraints from the point of view of fabrication. Apart from the F4E teams, our contractors CEA/Framatome (France) and Esteyco (Spain) also participated in the exchange.



Designing and manufacturing experts meeting in Barcelona. The European Test Blanket Module (TBM) programme is working on the design and manufacturing of two of them. June 2022. ©F4E

# IN-VESSEL

The extremely hot temperature of the fusion plasma will be mostly felt by the In-Vessel components, otherwise known as plasma-facing components, due to their direct exposure to high heat and neutron fluxes. The divertor, likened to a massive “ashtray” where the plasma ashes and impurities are diverted to, consists of 54 cassettes, all to be manufactured by Europe, and is located at the lower part of the machine. The blanket is made of the 440 modules, the first wall panels, covering the walls of the vacuum vessel. Europe is responsible for the production of 215 of them.

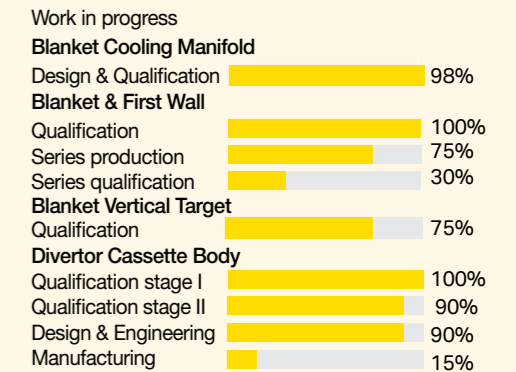

## Contract signed for the production of first Divertor Cassette Bodies

F4E will manufacture 58 Inner-Vertical Targets (IVTs) to match the production of 54 cassettes plus 4 spares. Their fabrication will be structured in stages. In a call for tender previously launched, three companies made it to the finish line qualifying for the production of IVTs: AES Consortium (Ansaldo Nucleare, Ansaldo Energia and SIMIC), Alsymex, and Research Instruments (RI). This allows F4E to explore the manufacturing of these components in sequence with the three entities, should there be any complications. In 2022 one contract was signed with RI to produce 13 IVTs, expected to be completed by 2027. Through another contract, the production of another series of 13 IVTs will follow.



Inner-Vertical Target prototype produced by Research Instruments, Germany. F4E has will manufacture 58 Inner-Vertical Targets (IVTs) to match the production of 54 cassettes plus 4 spares. ©RI

# HEATING & CURRENT DRIVE

To heat the ITER plasma and raise its temperature, we plan to use several systems. For example, Neutral Beam Heating (NBH), to release high-energy negative beams, and the Electron Cyclotron (EC), to inject into the gas high-energy electromagnetic waves.

For the NBH, given the ambitious technological leap from similar systems worldwide to those of ITER, a dedicated test facility, known as the Neutral Beam Test Facility (NBTF), has been set up in Padua, Italy. It is the host of two experiments, SPIDER, dedicated to the development of the ion source, which started operations in 2018, and MITICA, which is in progress, dedicated to the development and test of a full-size prototype of an ITER Neutral Beam Injector.

F4E is currently completing its contribution to the NBTF, focusing on the MITICA beam source and beam line components, while in parallel advancing with the fabrication of the first ITER Neutral Beam components.

Europe is also contributing to Electron Cyclotron (EC) systems with the manufacturing of several sets of dedicated power supplies, six gyrotrons, four upper launchers, and associated ex-vessel waveguide systems.

F4E is actively collaborating with engineering companies and European fusion laboratories for the design, fabrication, and delivery of these components.

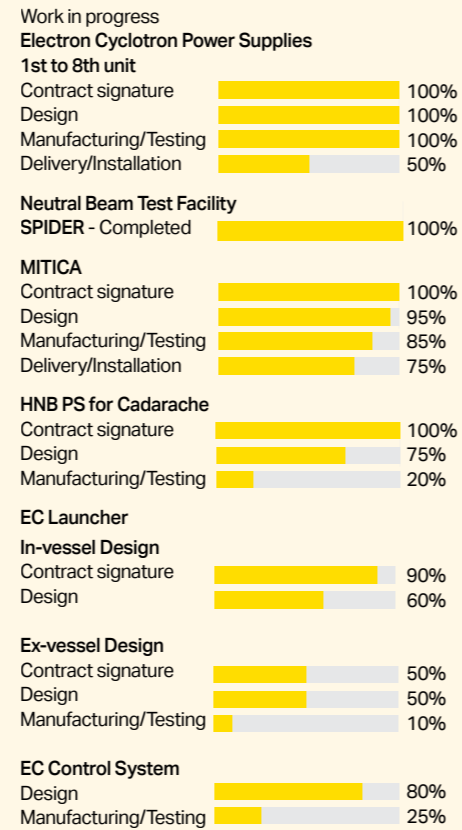

## Manufacturing of ITER MITICA Beam Source advancing

There was more progress with manufacturing of the MITICA beam source, to which more than 20 European companies from Germany, Netherlands, Italy, France are contributing. The components are gathered at the ALSYMEX factory in Tarbes, France, to be assembled. In 2022, nearly all manufacturing activities, and sub-assembly of components were completed. In parallel, the fabrication of the MITICA cryopump, which is necessary for the vacuum conditions, was almost completed.

## More power supplies delivered on-site and new contracts placed

In the field of power supplies, the final two of the eight high voltage units for the electron cyclotron passed the factory acceptance tests and were delivered to the ITER site. Meanwhile, the installation of power supplies, commissioning, and site testing in the ITER Radiofrequency Building kept advancing. There was also good progress with the procurement of the gyrotrons. F4E signed a contract with Thales for the production of six of these devices that will produce radio frequency waves to be used by the electron cyclotron. Last, but not least, a multi-million contract was signed with the consortium of IDOM and Alsymex, for the design and manufacturing of four upper launchers and five ex-vessel waveguides to assist with the heating of ITER plasma.

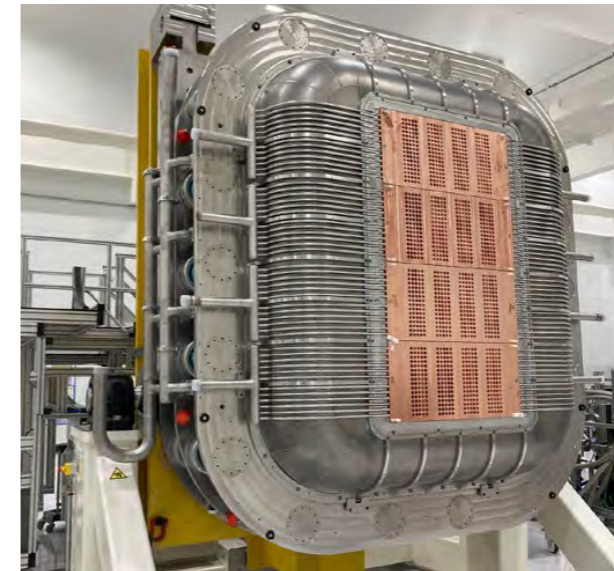

View of the MITICA beam source, mounted on an assembly structure, financed by F4E and manufactured by Alsymex and industrial partners, Tarbes, France, May 2022. ©Alsymex



Segments of the MITICA beam source accelerator components prior to being assembled, Alsymex, Tarbes, France, May 2022. ©Alsymex



View of the Alsymex clean room facility, where the assembly of the MITICA beam source is progressing, Tarbes, France, May 2022. ©Alsymex

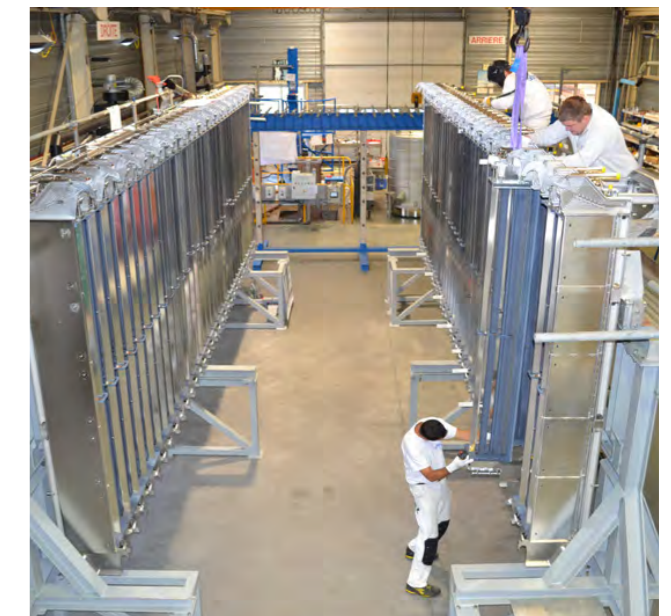

Operators placing a pumping section in the MITICA (Megavolt ITER Injector and Concept Advancement) Cryopump, France, October 2022. ©SDM

One of the two sets of high-voltage power supplies for the electron cyclotron resonance heating (ECRH) system installed on the second floor of the Radio Frequency Building. November 2022. ©ITER Organization.



Operators checking the alignment of equipment connected to the European gyrotron prototype at the Falcon test facility in the Swiss Plasma Center, EPFL, Switzerland, July 2022. ©EPFL

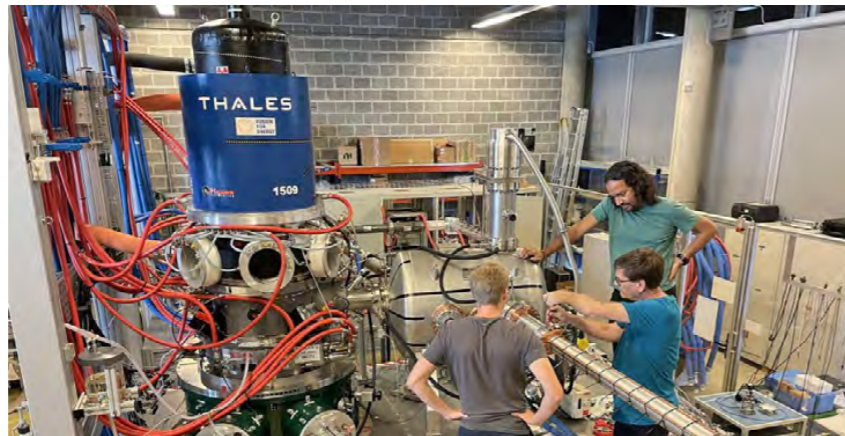
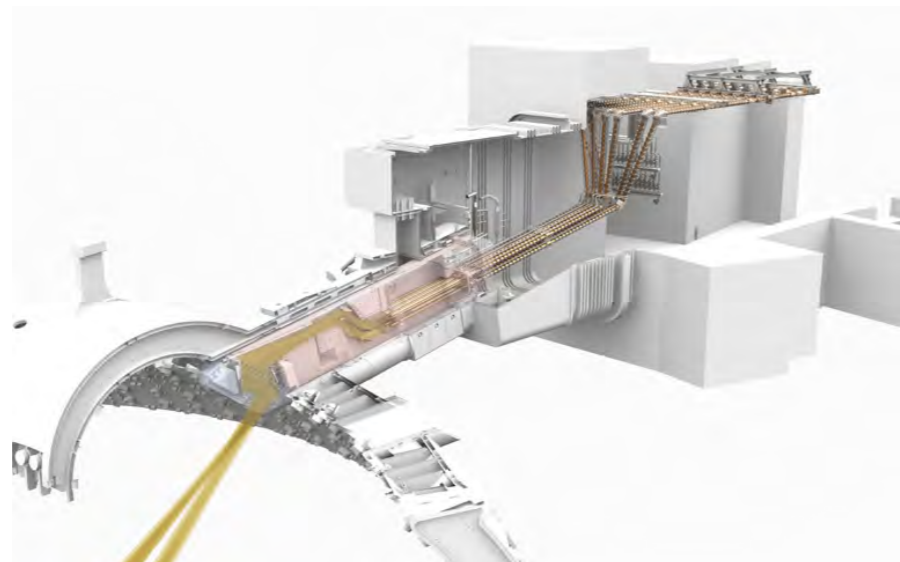
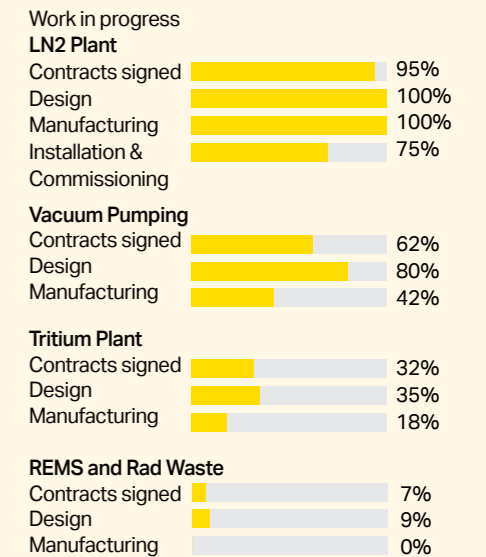

Illustration of one ITER Electron Cyclotron Upper Launcher and associated waveguide system, July 2022. © IDOM



# CRYOPLANT AND FUEL CYCLE

The ITER machine will have to cope with extreme temperature fluctuations. Cold helium will circulate inside the magnets to bring their temperature down to -269 °C in order to confine the hot plasma. The magnets, thermal shields and cryopumps will have to be cooled down and maintained with the help of one of the most advanced cryogenic systems to date. The cryoplant can be described as a massive refrigerator that will generate the freezing cold temperatures required for the fusion machine. Europe is responsible for the Liquid Nitrogen (LN2) Plant and its auxiliary systems.



## Helium Tanks filled up

Following the commissioning and filling of the helium storage tanks, the F4E-ITER Organization Cryogenics Team made progress with the distribution line to supply helium to all the other parts of the cryoplant. In parallel, the commissioning of the liquid nitrogen (LN2) plant progressed. A 26 m tall cylinder, with a storage capacity of 300 m<sup>3</sup>, was cleaned and purged to remove impurities. The tank was cooled and filled up to 80 % of its capacity, which is the usual working level.



Liquid nitrogen stored inside the tank of the ITER Cryoplant, Cadarache, France, April 2022. ©ITER Organization

## Four Cold Valve Boxes completed

With regards to fuel cycle components, four of the eight Cold Valve Boxes (CVBs) have been produced by Research Instruments (RI) and their subcontractor Cryoworld. Each of them will distribute helium to the cryopumps and connect them to the refrigeration system. In ITER, cryopumps will ensure the correct vacuum conditions inside the vacuum vessel and the cryostat.



Two cold valve boxes (CVBs) in the workshop of Research Instruments, Germany. F4E, in collaboration with Research Instruments (RI) and Cryoworld, has already completed four CVBs. August 2022. ©RI

# 03

---

## The Broader Approach

---

### Taking a step closer to fusion energy through Research & Development

---

Bringing together two parties that share the same vision on how to address fusion research challenges summarises the spirit of collaboration in the “Broader Approach”. In February 2007, an Agreement was signed between Europe and Japan, complementing the ITER project, to promote R&D in the field of fusion technologies.

The Broader Approach consists of three projects:

- The Satellite Tokamak, known as JT-60SA, a fusion device about half the size of ITER to study plasma operations;
- The International Fusion Materials Irradiation Facility - Engineering Validation and Engineering Design Activities (IFMIF-EVEDA), an installation built to design, test and qualify the materials for future fusion power plants;
- The International Fusion Energy Research Centre (IFERC) comprising three sub-projects for plasma remote experimentation and simulation.

The first phase of the three projects was completed. In 2020, the second phase of the Broader Approach Agreement was signed, offering continuity to this valuable partnership between the European Union and Japan.

# JT-60SA

The JT-60SA is the largest tokamak in the world until ITER starts operations. Located in Naka, Japan, this device is the upgrade of an existing tokamak to be capable of long pulse operation. The upgrade involved the complete dismantling of the old device, the refurbishing of the buildings, the upgrade of power supply and heating systems. This experimental device will support ITER through complementary experiments in order to improve the design of the Demonstration (DEMO) fusion reactor, which will be connected to the grid.

## Team spirit, resilience, and adaptability key to JT-60SA repairs

Towards the end of 2020, engineers started testing the performance of JT-60SA. The first results were reassuring but an unexpected turn of events in March 2021 changed all plans due to a short circuit at the terminals of one of the machine's largest poloidal field coils. As a result of this incident, a thorough analysis was conducted, and the circuit was attributed to areas where electrical insulation was performed manually.

In total, 90 locations needed to be repaired and the machine sensors had to be rewired. Engineers took immediate action and concluded that damages were limited, since the incident happened at low current. Nevertheless, they did produce helium leakage and the machine was shut down. In some cases, repairing this equipment was going to be difficult given the limited access in the device and the risk of a further delay for first plasma operations. The team of engineers did not give up and remained focussed on repairs.

From August until September, they performed Paschen tests, which consist of energising all magnet circuits under controlled vacuum. In total, 90 locations needed to be repaired and the machine sensors had to be rewired. To many this would have been a blow to their motivation. To the JT-60SA team, however, it was a period of reflection by joining forces to fix the device and deliver.

These efforts started in May 2021 and lasted roughly a year, counting on the involvement of F4E and other experts from Europe and Japan, in validating root causes and carrying out repairs.

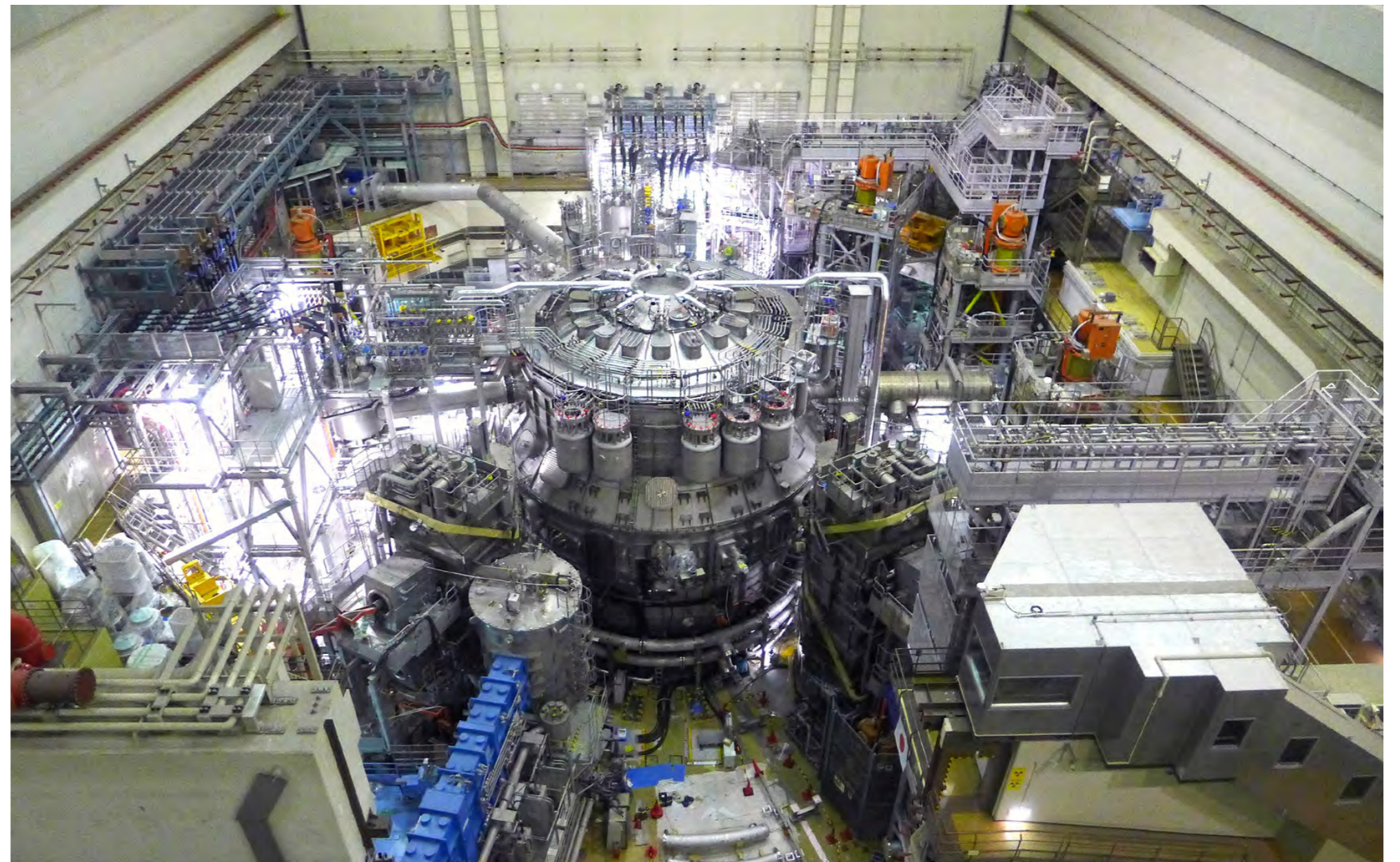

View of JT-60SA device, Naka, Japan, 2022 © QST/F4E

# LIPAC – IFMIF

Reproducing the conditions of the future fusion reactors is the objective of the International Fusion Materials Irradiation Facility (IFMIF). This accelerator-based facility will test materials similar to the conditions of the DEMO reactor, which will follow ITER. The know-how acquired will help engineers to improve the durability of materials and minimise their activation. The Engineering Validation and Design Activities (EVEDA) for IFMIF are conducted in Rokkasho, Japan.

## LIPAc accelerator prepares for continuous beam operation

Work on the Linear IFMIF Prototype Accelerator (LIPAc) continued at full speed after the successful beam operation of 2021. This accelerator, jointly developed by Europe and Japan in the framework of the Broader Approach agreement, aimed to validate the design of a future neutron source to test materials for fusion machines that will follow ITER.

In January 2022, experts started to prepare to operate the accelerator at what they call continuous wave (using a continuous beam instead of a pulsed one) and nominal conditions. Meanwhile, a large helium tank was installed in the cryoplat. This was the second storage, and it was connected to the cryogenic system and filled with pure helium.



Commissioning and operation from the central control room. Rokkasho. © IFMIF/EVEDA

# IFMIF-DONES



His Majesty the King of Spain addressing the audience during the IFMIF-DONES Forum, Zagreb, Croatia, November 2022. © IFMIF-DONES

## Spain and Croatia sign IFMIF-DONES Agreement

Spain and Croatia agreed to the terms of the new research infrastructure that will be constructed in Granada, Spain, to help scientists test materials for future fusion devices. Escúzar was named as the construction site, and a series of campaigns were flagged as a priority so that the scientific community uses the infrastructure to conduct experiments. The impact of this facility will be profound both in the fields of R&D and industry to improve their expertise in fusion technology. The Memorandum of Understanding signed between Spain and Croatia set the terms of collaboration between the two parties to establish the International Fusion Materials Irradiation Facility -Demo Oriented Neutron Source (DONES).



(L-R) Their Majesties the Queen and King of Spain, and the President of the Republic of Croatia with his wife. Front row: (L-R) Diana Morant, Spain's Minister of Science and Innovation, signing the Memorandum of Understanding with Radovan Fuchs, Croatia's Minister of Science and Education, Zagreb, Croatia, November 2022 © IFMIF-DONES



# 04

---

## Working together with stakeholders

---

F4E actively engaged with European and national stakeholders through periodic updates and the communication of success stories highlighting the direct and indirect benefits of the project. ITER is a motor of economic growth, innovation and competitiveness, ultimately making a contribution to a sustainable energy mix for the future.

With the support of various F4E committees and the network of ITER Industrial Liaison Officers (ILOs), various initiatives were undertaken to reach out to industry, SMEs and research organisations in order to get involved.

To strengthen the spirit of partnership between ITER Parties, Europe maintained its firm commitment to building stronger ties by improving the flow of information and the exchange of good practice.

### Members of the European Parliament visit ITER

A delegation of 11 Members of the European Parliament (MEPs), from nine countries and four political groups, travelled to Cadarache. The visit to the ITER site provided an excellent opportunity to check on the progress of the project and discuss the benefits arising from its European leadership.



The delegation inside the ITER Assembly Hall. February 2022. ©ITER Organization

### Nordic ITER Business Forum

F4E had a prominent presence at the Nordic ITER Business Forum, that brought together a hundred people at the Technical University of Denmark. This event is aimed at informing companies about the ITER project, the business opportunities and the available support when preparing and submitting tenders.



Leonardo Biagioni, F4E Commercial Department, during his talk on the ITER Project. Technical University of Denmark, March 2022. ©European Commission

### First F4E Neutronics Workshop

Over 80 people affiliated to 18 organisations, including laboratories, ITER Organization, ITER Domestic Agencies, academia, and industry, participated in the first F4E Neutronics workshop. The virtual event lasted three half-days and served as a platform for dissemination and discussion of nuclear fusion analysis developments, results, and expertise.

### Symposium on Fusion Technologies (SOFT)

F4E participated in the Symposium on Fusion Technologies (SOFT) held in Dubrovnik, Croatia. One of the most expected parts of the event was the ceremony of the SOFT Innovation Prize, aimed at promoting an entrepreneurial culture in fusion research by recognising outstanding researchers or industries that find innovative solutions to fusion challenges. The second and third prizes were awarded to technologies developed – at least partially – in the framework of a collaboration with F4E.



Winners of the SOFT Innovation Prize, September 2022 ©SOFT

### Barcelona Sustainable Energy Days

F4E co-organised the Sustainable Energy Days in Barcelona together with the UPC BarcelonaTech University, the Government of Catalonia and the municipalities of Barcelona and Sant Adrià de Besòs, within the framework of the European Sustainable Energy Week.

The 2022 edition focused on energy future in three ways: an annual event to showcase the world-class research done at Campus diagonal-Besòs, conferences by professionals, experts and EU representatives, and the plenary with younger participants debating challenges of science.



Stavros Chatzipanagiotou, F4E Head of Communications, addressing the audience in the Barcelona Sustainable Energy Days, September 2022, @BTEC.

### Big Science Business Forum

Delegates from big science organisations, research foundations, companies and large-scale infrastructures met in the field of Big Science Business Forum (BSBF) 2022 to hear the latest in the field of procurement, business opportunities and technology transfers. For the first time ever, thanks to the collaboration of F4E and CDTI volunteers, a session on “Women in Big Science” shed some light on the systemic and organisational challenges women experience in this context.



Representatives of F4E, CDTI, Ministry of Science and Innovation, members of the panel discussion at the Women in Big Science session, BSBF 2022, Granada, Spain, October 2022. ©F4E

### Chairing the EU Agencies Network

In its role as chair of the EU Agencies Network (EUAN), F4E hosted several meetings organised by the different subnetworks

conforming the Network, including the Heads of Agencies, Heads of Resources and Heads of HR from all EU Agencies. These annual meetings provided an opportunity to discuss the work done jointly throughout the year and set the priorities for the upcoming months.



The Heads of Agencies annual meeting took place in Barcelona, on 6-7 October 2022. ©F4E



Pietro Barabaschi, F4E Director ad interim, shakes hands with Pere Aragonès, President of the Generalitat de Catalonia. October 2022. ©Gencat

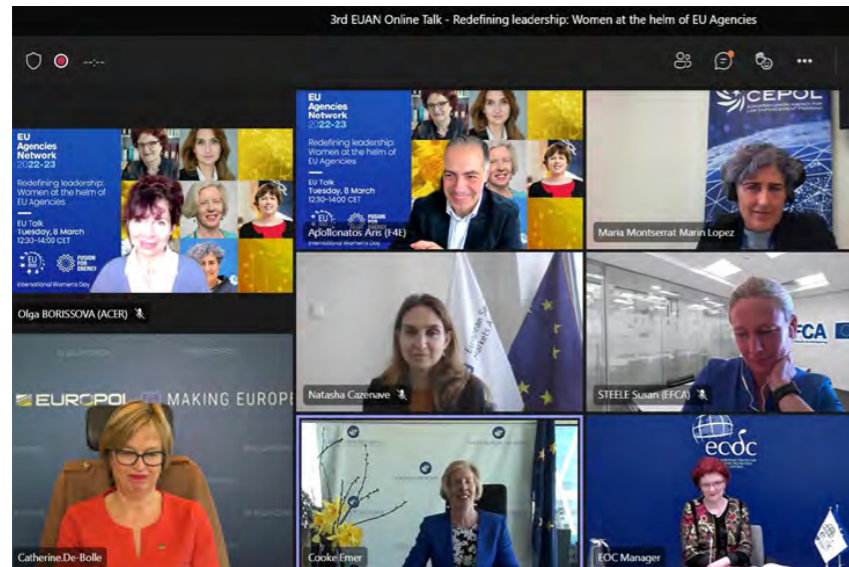

Photo group of the attendees to the Inter-Agency Legal Network (IALN) plenary session. November 2022. ©F4E



## Contributing to the promotion of diversity and inclusion

As chair of the EU Agencies, F4E launched several actions in order to foster diversity and inclusion among the Network. One of them was the EUAN online talk Redefining leadership: Women at the helm of EU Agencies, organised by F4E on 8 March 2022. The event gathered women Executive Directors from the EU Agencies, who shared their thoughts and experiences on the challenges women leaders face. Over 500 attendees from 34 EU Agencies (85% women) registered for the webinar –a record-breaking number.



Screenshot of the EUAN Online Talk, Redefining leadership: Women at the helm of EU Agencies, March 2022. ©F4E  
 Top row: Olga Borissova (ACER), Chair of EUAN Diversity and Inclusion Network, Aris Apollonatos (F4E), moderator, Maria Montserrat Marin Lopez, Executive Director of the European Union Agency for Law Enforcement Training (CEPOL).  
 Middle row: Natasha Cazenave, Executive Director of the European Securities and Markets Authority (ESMA), Susan Steele, Executive Director of the European Fisheries Control Agency (EFCA).  
 Lower row: Catherine De Bolle, Executive Director of the European Union Agency for Law Enforcement Cooperation (Europol), Emer Cooke, Executive Director of the European Medicines Agency (EMA), Andrea Ammon, Director of the European Centre for Disease Prevention and Control (ECDC)

Throughout the presidency, F4E also produced and shared with all EU Agencies communication material for EU Diversity Month, Pride Month, International Men's Day, and Disabilities Day.



Visuals of the campaign launched on the occasion of International Men's Day 2022. It was awarded a certificate of Excellence by the jury of the EUAN D&I Award. November 2022. ©F4E

## Getting in touch with the EU

---

### In person

All over the European Union there are hundreds of Europe Direct information centres. You can find the address of the centre nearest you at: [https://europa.eu/european-union/contact\\_en](https://europa.eu/european-union/contact_en)

### On the phone or by email

Europe Direct is a service that answers your questions about the European Union. You can contact this service:

- by freephone: 00 800 6 7 8 9 10 11 (certain operators may charge for these calls),
- at the following standard number: +32 22999696 or
- by email via: [https://europa.eu/european-union/contact\\_en](https://europa.eu/european-union/contact_en)

## Finding information about the EU

### Online

Information about the European Union in all the official languages of the EU is available on the Europa website at: [https://europa.eu/european-union/index\\_en](https://europa.eu/european-union/index_en)

### EU publications

You can download or order free and priced EU publications at: <https://publications.europa.eu/en/publications>. Multiple copies of free publications may be obtained by contacting Europe Direct or your local information centre (see [https://europa.eu/european-union/contact\\_en](https://europa.eu/european-union/contact_en)).

### EU law and related documents

For access to legal information from the EU, including all EU law since 1952 in all the official language versions, go to EUR-Lex at: <http://eur-lex.europa.eu>

### Open data from the EU

The EU Open Data Portal (<http://data.europa.eu/euodp/en>) provides access to datasets from the EU. Data can be downloaded and reused for free, for both commercial and non-commercial purposes.

### PDF

ISBN 978-92-9214-043-4  
ISSN 2363-3212  
doi: 10.2827/258088

### Print

ISBN 978-92-9214-042-7  
ISSN 2363-3204  
doi: 10.2827/579981

Neither Fusion for Energy (F4E) nor any person acting on behalf of Fusion for Energy (F4E) is responsible for the use that might be made of the following information.

Luxembourg: Publications Office of the European Union, 2023

© Fusion for Energy Joint Undertaking, 2023

Reproduction is authorised provided the source is acknowledged.

For any use or reproduction of elements that are not owned by Fusion for Energy, permission may need to be sought directly from the respective rightholders.

## Fusion for Energy

The European Joint Undertaking for ITER  
and the Development of Fusion Energy

C/ Josep Pla, n° 2  
Torres Diagonal Litoral  
Edificio B3  
08019 Barcelona  
Spain

Telephone: +34 933 201 800  
Fax: +34 933 201 851  
E-mail: [info@f4e.europa.eu](mailto:info@f4e.europa.eu)



[www.fusionforenergy.europa.eu](http://www.fusionforenergy.europa.eu)



[www.twitter.com/fusionforenergy](https://twitter.com/fusionforenergy)



[www.youtube.com/fusionforenergy](https://www.youtube.com/fusionforenergy)



[www.flickr.com/photos/fusionforenergy](https://www.flickr.com/photos/fusionforenergy)



[www.linkedin.com/company/fusion-for-energy](https://www.linkedin.com/company/fusion-for-energy)

ISBN 978-92-9214-043-4



Fusion for Energy  
receives funding  
from the European  
Union budget



Publications Office  
of the European Union